



HOPE INDUSTRIAL SYSTEMS



22" PANEL MOUNT INDUSTRIAL MONITOR

REVISION D

USER MANUAL

Model No. HIS-ML22- __ _ D



Table of Contents

Safety and Regulatory Information	3
FCC Notice	3
Hazardous Locations	4
Waste Electrical and Electronic Equipment Directive (WEEE)	4
Mechanical Drawings	5
Front View.....	5
Bottom View.....	5
Rear View	6
Side View.....	6
Installation Instructions	7
Step 1: Prepare for Installation	7
Step 2: Bench-test Configuration.....	8
Connect Video and Power Cables	8
Connect and Set Up Touch Screen.....	10
Step 3: Install into Panel	12
Video Settings	14
Setting the Timing Mode	14
Control Panel Buttons.....	15
On-Screen Display (OSD) Menus.....	17
Picture Menu.....	17
Display Menu	20
Setup Menu.....	22
Info Menu	25
Cleaning Instructions	26
Troubleshooting	27
Video Troubleshooting	27
Touch Screen Troubleshooting	29
Specifications	30
Display	30
Environmental	30
Video	31
Functional	31
Physical	32
Electrical	32
Compliances and Certifications	33
Warranty Statement	34



Safety and Regulatory Information



WARNING!

To prevent fire or shock hazard, do not expose live components to rain or moisture. Dangerously high voltages are present inside the unit. Do not disassemble the unit. Refer servicing to qualified personnel only. Operator could be exposed to dangerously high voltage if AC power is not connected properly. Verify all wiring is properly connected.

This equipment is not intended for use in critical applications where its failure to operate would create immediate life threatening circumstances. Applications including, but not limited to, nuclear reactor control, aerospace navigation systems and life support systems are not appropriate for this product.

This product is intended to be mounted in a suitable cabinet or other enclosure. The NEMA 4, 4X, or 12 ratings are applicable only when properly installed in a like rated enclosure.

DC Supplied Units only: The HIS-ML22 subject unit is to be powered by a Listed Power Supply suitable for the application with outputs at SELV/LPS or Class 2 levels rated 9.6-36.6VDC, 2.5 A max. The equipment is not intended to connect directly to a DC Mains source.

FCC Notice

This equipment has been tested and found to comply with the limits for a Class A digital device, pursuant to Part 15 of the FCC Rules. These limits are designed to provide reasonable protection against harmful interference when the equipment is operated in a commercial environment. This equipment generates, uses, and can radiate radio frequency energy and, if not installed and used in accordance with the instruction manual, may cause harmful interference to radio communications. Operation of this equipment in a residential area is likely to cause harmful interference in which case the user will be required to correct the interference at his own expense. Any changes or modifications not expressly approved by the grantee of this device could void the user's authority to operate the device.

Hazardous Locations

This equipment is suitable for use in Class I, Division 2, Groups A, B, C, and D; Class II, Division 2, Groups F and G; Class III; or non-hazardous locations only.

Device is open-type and is to be installed in an enclosure suitable for the environment that is only accessible with the use of a tool.

FR: Cet équipement peut être utilisé dans la Classe I, Division 2, Groupes A, B, C et D; Classe II, Division 2, Groupes F et G; et Classe III, endroits hasardeux ou endroits non-hasardeux seulement. Cet appareil doit être installé dans un enclos adapté à un environnement accessible uniquement avec l'aide d'un outil.

WARNING – EXPLOSION HAZARD – Do not disconnect equipment unless power has been removed or the area is known to be non-hazardous.

WARNING – EXPLOSION HAZARD – Substitution of any components may impair suitability for Class I, II & III, Division 2 Locations.



Any steps marked with this symbol are required to ensure compliance with Class I, II, III, Division 2 Hazardous Location requirements.

Waste Electrical and Electronic Equipment Directive (WEEE)

The following information is only for EU-member states and the UK:

The mark shown to the right indicates compliance with the Waste Electrical and Electronic Equipment Directive 2012/19/EU (WEEE 2) amending Directive 2002/96/EC. The mark indicates the requirement NOT to dispose of the equipment as unsorted municipal waste, but use the return and collection systems according to local law.



The European Union WEEE Regulations of 2014 require producers of electrical and electronic equipment to finance the takeback of WEEE resulting from products that we place on the market. Hope Industrial Systems will take back WEEE, free of charge, when purchased directly from us. Please contact support for details.

Mechanical Drawings

Front View

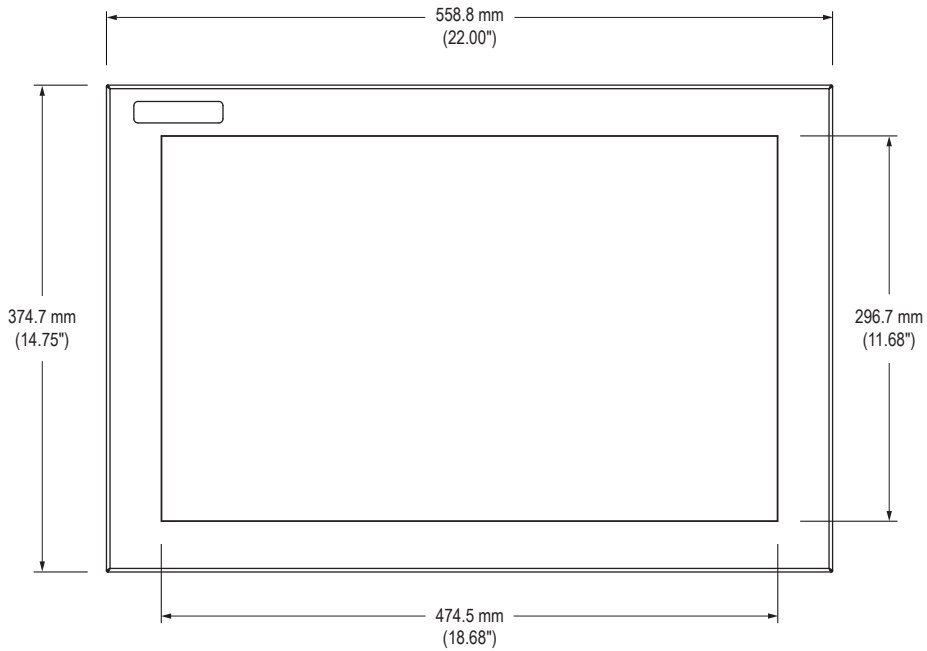

Bottom View

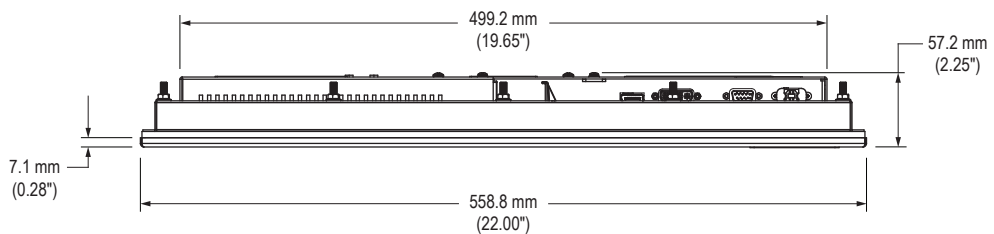

Rear View

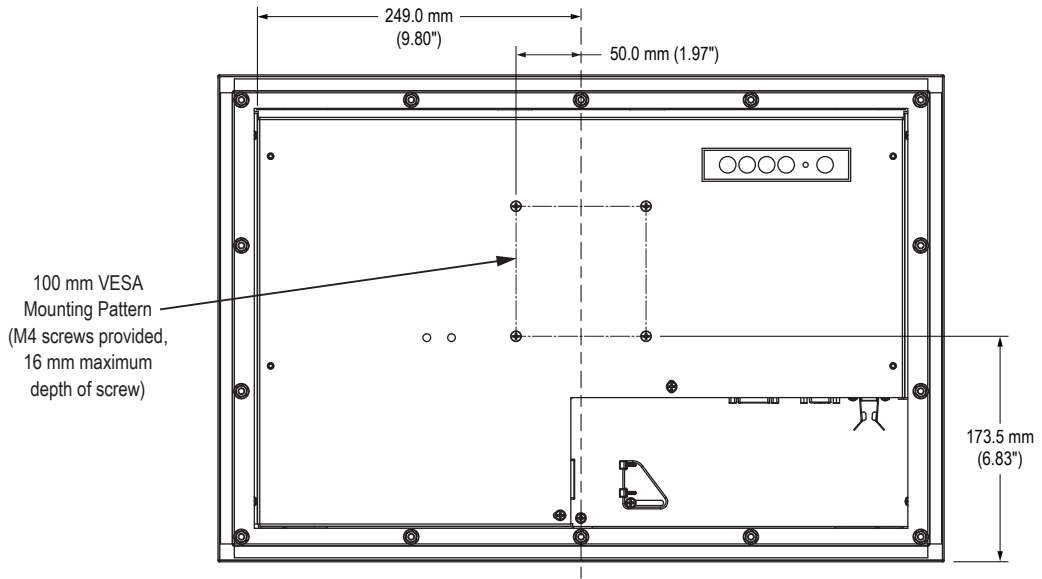

Side View

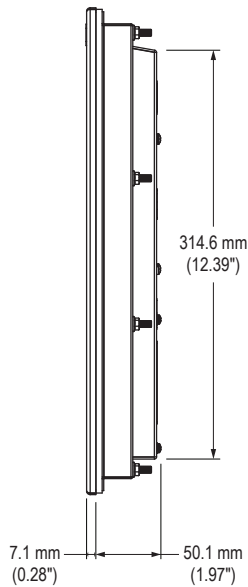

Installation Instructions

Step 1: Prepare for Installation



IMPORTANT!

Perform the following steps **BEFORE** installation of the monitor into the panel.

1. Ensure that sufficient power is available.
2. Ensure that sufficient space is available to allow for proper air flow into and out of the unit.
3. Ensure that the air temperature around the unit (top and bottom) *will not exceed the rated specifications of the unit.*



- ▶ **The maximum rated temperature for the HIS-ML22 is 50°C (122°F).**
 - ▶ **Remember that heat rises – the temperature at the top of the cabinet will be much hotter than at the bottom if air inside the enclosure is not actively circulating. Even in a sealed enclosure, use of a circulation fan can greatly reduce temperature.**
 - ▶ **Also, remember that even though this product is designed to operate at 50°C, the life span of any electronic device is shortened when it is consistently operated at high temperatures. Therefore, it is wise to take steps to keep the temperature of the ambient air around the unit as low as possible.**
4. Ensure that the ambient humidity of the air around the unit *does not exceed the specifications of the unit.*
 - ▶ **The maximum rated humidity for the HIS-ML22 is 90% non-condensing.**

Step 2: Bench-test Configuration

Make sure everything works before installing into the production environment.



TIP!

If using a KVM extender, please refer to the installation instructions included with the KVM extender module. It is particularly important to bench-test the full configuration prior to final installation. This will help to identify and troubleshoot any system issues while configuration changes may still be easily made.

Connect Video and Power Cables

The cable ports are located on the rear of the monitor.

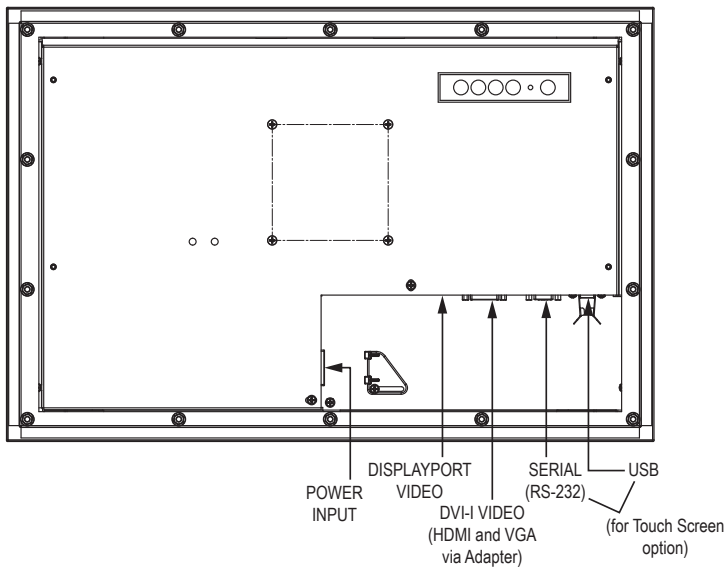

Video Connection

DisplayPort connections are supported natively with the integrated DisplayPort connector. Optional adapters are available for Mini DisplayPort.

An integrated DVI-I connector is used to support both digital (DVI, HDMI) and analog (VGA, RGB) signals through the same port. VGA signals require use of a VGA to DVI adapter. RGB video sources (BNC, RCA) require additional adapters. HDMI (including Mini and Micro) can also use the DVI-I port using an adapter.



After selecting the appropriate interface, connect one end of your video cable to the input port on the rear of the monitor. If using a DVI cable, secure the screw locks to ensure adequate strain relief. Connect the other end to the appropriate port on your host computer or other video source.



NOTE: If this step is not performed, the product will not comply with Class I, II, III, Division 2 Hazardous Location requirements.



TIP!

To avoid incompatibility issues, use only certified video adapters available from Hope Industrial Systems. Many 3rd-party signal adapters are known to cause signaling issues.

Power Connection

The HIS-ML22 is available with either AC or DC power input.

AC power input models accept 100 to 240 VAC, 1.5/0.75 A, 60/50 Hz. Loosen the retaining clip for the power cable on the rear of the monitor. Connect the AC power cable to the power input port on the monitor then retighten the retaining clip. Connect the other end into a nearby outlet.



NOTE: If the retaining clip screw is not tightened, the product will not comply with Class I, II, III, Division 2 Hazardous Location requirements.

DC power input models accept 9.6 to 36.6 VDC, 2.5 to 0.65 A, Class 2 or SELV/LPS.

1. With main power disconnected, hook up incoming power wires to the DC input terminal blocks according to the label markings. Securely tighten terminal block screws.
2. Plug the connector into the unit and secure by tightening the two side screws.

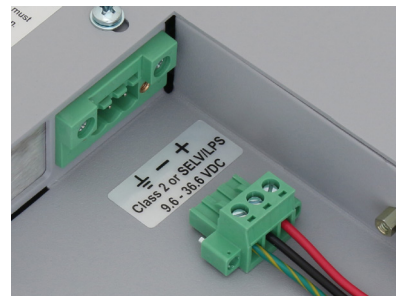

NOTE: If steps 1 and 2 are not performed, the product will not comply with Class I, II, III, Division 2 Hazardous Location requirements.

Connect and Set Up Touch Screen

Applies to touch screen monitors only. Instructions below apply to Windows systems.

Contact Hope Industrial Systems if you require a CD-ROM with documentation and touch screen drivers. For a full list of downloadable drivers, please check the following address:

<https://www.HopeIndustrial.com/support/drivers/>



IMPORTANT!

If you will be using a USB connection, *install the touch screen driver first*, and then connect the USB cable. If you will be using a Serial connection, *connect the Serial cable first*, and then install the touch screen driver.

All touch screen models include both USB and Serial (RS-232) ports for touch screen operation, but only one of these should be connected to the computer. When both ports are available on the computer, USB is preferred.

Installing the Driver: USB Connections

1. Do not plug the USB connection into the computer until the driver installation is complete. If the USB connection has already been made, disconnect at this point.
2. Download the appropriate driver for your operating system from the address listed above. Click to "Run" the software when prompted.
3. Follow the on screen prompts to complete the driver installation.
4. Once the driver has been successfully installed, the USB connection can be made by inserting the connector through the monitor's integrated cable retention bracket and into the USB port. Connect the other end to the USB port on the host computer.
5. Proceed with Calibration on page 11.

Note: detailed and up-to-date USB driver installation instructions can be found at the following address:

<https://www.hopeindustrial.com/blog/calibrating-a-touch-screen/>

Installing the Driver: Serial (RS-232) Connections

Serial Connections must be made before installing the driver.

1. Connect one end of the Serial cable to the Serial input port on the rear of the monitor. Connect the other end to the Serial port on the host computer. Tighten the screw locks on the cable connectors to ensure adequate strain relief.



NOTE: If this step is not performed, the product will not comply with Class I, II, III, Division 2 Hazardous Location requirements.

2. Download the appropriate driver for your operating system from the address listed on page 10. Click to "Run" the software when prompted. Follow the on screen prompts to complete the driver installation.
3. Proceed with Calibration (below).

Calibrate the Touch Screen

Once the driver has finished installing, you are ready to calibrate the touch screen.

Open the Windows Control Panel and ensure the "View by" option is set to "Small icons" in the top right of the window. Click the Elo icon to open the Elo Touchscreen utility.



Under the "General" tab, click the "Align" button to start the calibration routine.



Step 3: Install into Panel

Once you have completed the full bench-test configuration and confirmed that all components are working properly, you are ready to install the monitor into its panel cutout.



WARNING!

Hope Industrial Systems will not assume liability for damage to internal electronics due to improper installation. Contact Hope Industrial Systems if you need additional assistance.

1. Refer to the drawing below for the cutout dimensions for the HIS-ML22.

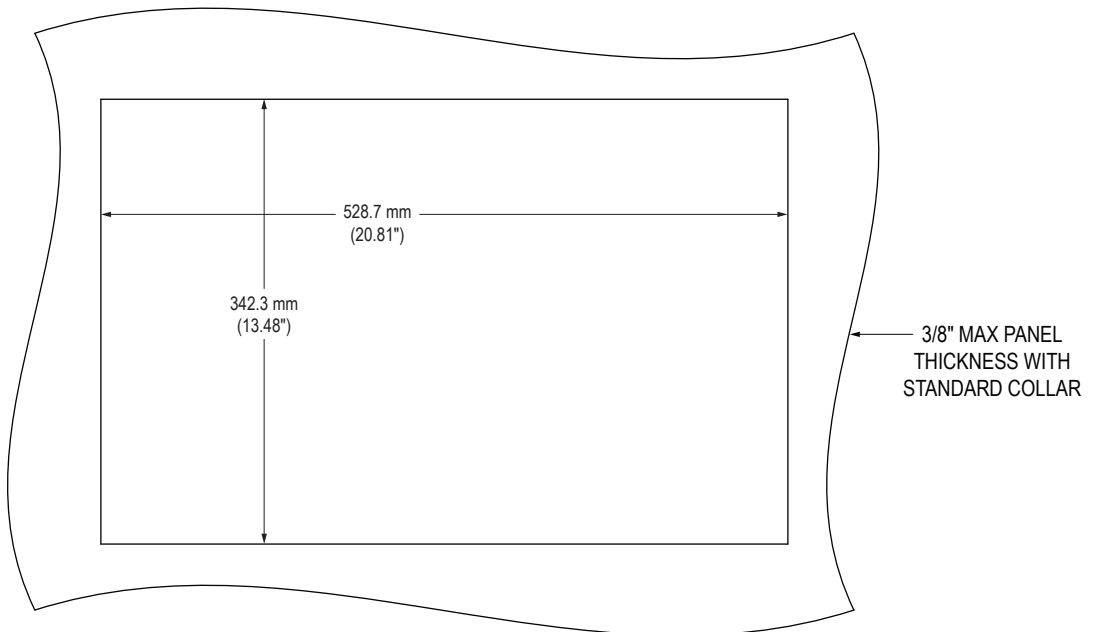

2. Locate position in panel for mounting of the monitor. Ensure that there is adequate space behind the panel. Allow 12.7 mm (0.5") extra space behind and on each side for air ventilation.

- Cut a rectangular hole in the panel.

► **Cutout Dimensions (W x H) for the HIS-ML22:**

528.7 mm x 342.3 mm (20.81" x 13.48"); ± 0.5 mm (0.020")

- Clean and deburr the panel hole.
- Separate the rear collar from the monitor by removing the 14 nuts.
- Refer to the enclosure mounting diagram below.

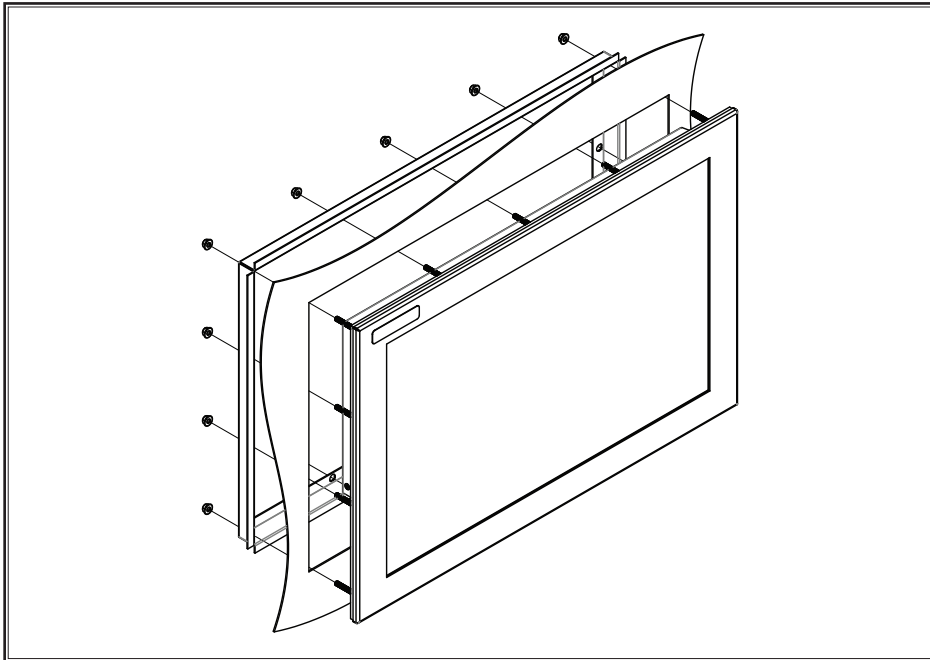

- Insert the unit into the front of the panel and re-attach the collar.

NOTE: Contact Hope Industrial Systems if for any reason your application does not allow for installation of the collar.

- Tighten all 14 nuts to a torque of 1.13-1.7 N-m (10-15 inch-pounds) to ensure a watertight seal between the bezel gasket on the monitor and the equipment panel. Go around all nuts twice to ensure an even compression on gasket.

NOTE: If a torque wrench is not available, tighten all nuts evenly until bezel sits 1.6 to 2.4 mm (1/16" to 3/32") off the front of the panel.

Video Settings

Setting the Timing Mode

Setting the timing mode of your computer graphics adapter (or other video source) is important for maximizing the quality of the screen image and for minimizing eye strain. The timing mode consists of the resolution (e.g. 1680 x 1050) and refresh rate (or vertical frequency; e.g. 60 Hz). After setting the timing mode, use the On-Screen Display (OSD) controls to adjust the screen image.



TIP!

For the best picture quality, set your computer graphics adapter timing mode to:

VESA 1680 x 1050 @ 60 Hz

Please refer to the computer graphics adapter manufacturer's manual for instructions on setting the resolution and timing mode. In Microsoft Windows, these settings may be found at the following location:

- ▶ **2000, XP:** Control Panel > Display > Settings
- ▶ **Vista:** Control Panel > Personalization > Display Settings
- ▶ **Windows 7, 8:** Control Panel > Appearance and Personalization > Adjust Screen Resolution
- ▶ **Windows 10, 11:** Start > Settings > System > Display





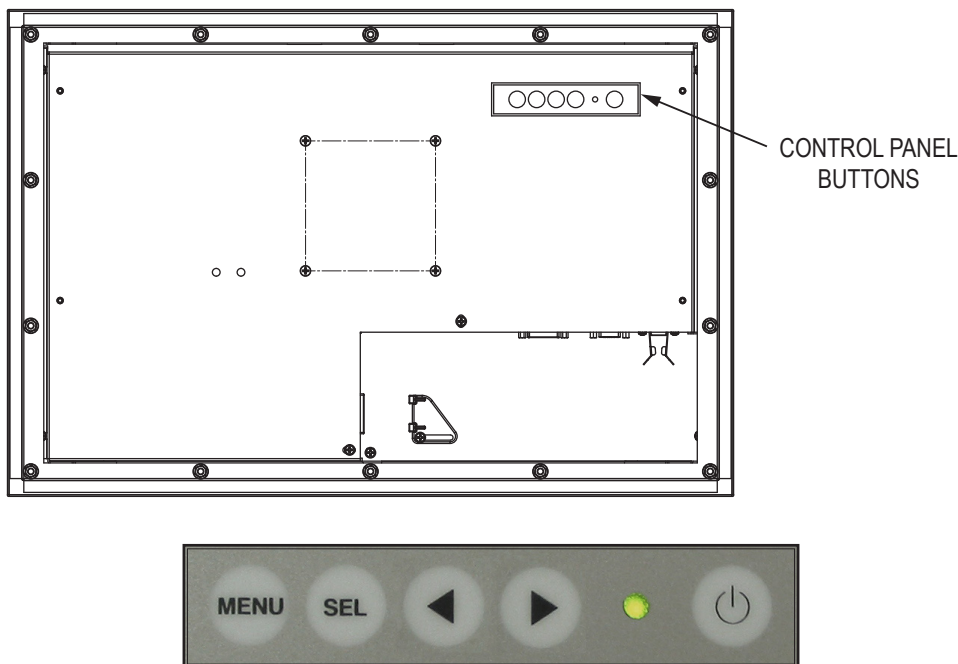

Control Panel Buttons

Use the control panel buttons located on the back of the monitor to display and adjust various settings on the On-Screen Display (OSD) menu.



1. To open the OSD menu, press the Menu button.

NOTE: All OSD menus and adjustments screens disappear automatically after 60 seconds. This is adjustable through the OSD Time out setting in the Setup menu.
2. To navigate through the main OSD menu, press the left [◀] or right [▶] button.
3. To select a control to adjust, press the Select [SEL] button to navigate down through the menu.
4. To adjust a selected control, press the left [◀] or right [▶] button, or press the right [▶] button to open the submenu for a selected control.
5. To return to the main OSD menu, press the Menu button.
6. To exit the OSD menu, press the Menu button.

Button	Control	Functions
	Menu	<ul style="list-style-type: none"> • Opens the OSD menu. • Exits the submenu. • Exits the OSD menu.
	Navigate Down / Auto Setup	When the OSD menu IS NOT displayed: <ul style="list-style-type: none"> • Shortcut to Auto Setup function.
	Left / Down / Backlight Adjust	When the OSD menu IS NOT displayed: <ul style="list-style-type: none"> • Shortcut to Backlight adjustment.
	Right / Up / Input Source	When the OSD menu IS NOT displayed: <ul style="list-style-type: none"> • Shortcut to select input source.
	Power Indicator Light	<ul style="list-style-type: none"> • LED lit green – power is ON • LED not lit or lit red – power is OFF • LED flashing orange – monitor is in Standby mode • LED flashing green – monitor is searching for display source
	Power	Turns the monitor on and off.

On-Screen Display (OSD) Menus

To open the OSD menu, press the Menu button once.

Main Menu	Description
Picture	Includes the Backlight, Contrast, Saturation, Sharpness, Color Balance, User Color, and Gamma functions.
Display	Includes the Aspect Ratio, Over Scan, and VGA Settings functions.
Setup	Includes the Input, Auto Scan, Advanced Setup, Reset to Factory Defaults, and OSD functions.
Info	Displays the monitor's Software Version, Software Revision, PA, Timing, and Mode ID.

Picture Menu

The Picture menu includes the Backlight, Contrast, Saturation, Sharpness, Color Balance, User Color, and Gamma functions.

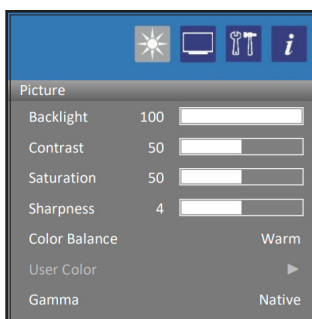

Picture Menu	Description
Backlight	<ul style="list-style-type: none"> Adjusts the background brightness. This feature may also be accessed by pressing the left [◀] button outside of the OSD menu.

Picture Menu	Description
Contrast	Adjusts the difference between the image background (black level) and the foreground (white level).
Saturation	Adjusts the intensity and vividness of the colors on the screen.
Sharpness	Adjusts the clarity of the screen to make the image sharper or softer.
Color Balance	<p>Provides several color adjustment modes, including preset color temperatures and a User mode that allows individual adjustment of Red, Green, and Blue. The factory default setting for this product is Warm.</p> <ul style="list-style-type: none"> • Warm adds red to the screen for warmer white and richer red. • Normal uses a color temperature of 6500°K. • Cold adds blue to the screen image for cooler white. • sRGB arranges the panel color to sRGB gamut. Enabling this setting allows the LCD to more accurately display colors the way they were originally intended. • User enables the "User Color" menu to allow for individual adjustment of Red, Green, and Blue.

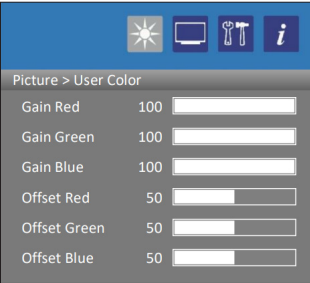

Picture Menu	Description																					
<p>User Color</p>	<p>The User Color submenu allows individual adjustment of Red, Green, and Blue.</p>  <p>The screenshot shows the 'Picture > User Color' submenu with the following settings:</p> <table border="1"> <thead> <tr> <th>Setting</th> <th>Value</th> <th>Slider</th> </tr> </thead> <tbody> <tr> <td>Gain Red</td> <td>100</td> <td>[Slider]</td> </tr> <tr> <td>Gain Green</td> <td>100</td> <td>[Slider]</td> </tr> <tr> <td>Gain Blue</td> <td>100</td> <td>[Slider]</td> </tr> <tr> <td>Offset Red</td> <td>50</td> <td>[Slider]</td> </tr> <tr> <td>Offset Green</td> <td>50</td> <td>[Slider]</td> </tr> <tr> <td>Offset Blue</td> <td>50</td> <td>[Slider]</td> </tr> </tbody> </table> <ul style="list-style-type: none"> • Gain Red adjusts the intensity of the red color in the brighter parts of the image. • Gain Green adjusts the intensity of the green color in the brighter parts of the image. • Gain Blue adjusts the intensity of the blue color in the brighter parts of the image. • Offset Red adjusts the red offset in the darker parts of the image. • Offset Green adjusts the green offset in the darker parts of the image. • Offset Blue adjusts the blue offset in the darker parts of the image. 	Setting	Value	Slider	Gain Red	100	[Slider]	Gain Green	100	[Slider]	Gain Blue	100	[Slider]	Offset Red	50	[Slider]	Offset Green	50	[Slider]	Offset Blue	50	[Slider]
Setting	Value	Slider																				
Gain Red	100	[Slider]																				
Gain Green	100	[Slider]																				
Gain Blue	100	[Slider]																				
Offset Red	50	[Slider]																				
Offset Green	50	[Slider]																				
Offset Blue	50	[Slider]																				
<p>Gamma</p>	<p>Adjusts the brightness of the image's colors to ensure they appear correctly on the screen. The factory default setting for this product is Native.</p> <ul style="list-style-type: none"> • Native displays high contrast images. • Low displays whitish images. 																					

Display Menu

The Display menu includes the Aspect Ratio, Over Scan, and VGA Settings functions.

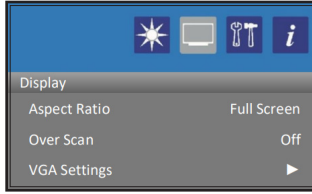

Display Menu	Description
<p>Aspect Ratio</p>	<p>Adjusts the aspect ratio of the image. The factory default setting for this product is Full Screen.</p> <ul style="list-style-type: none"> • Full Screen scales the input signal to fit the full screen. • Original displays the input signal in original format. • 4:3 scales the input signal to the 4:3 aspect ratio. • Smart 4:3 forces the display ratio to 4:3 if the input ratio is small 16:10.
<p>Over Scan</p>	<p>Allows the user to turn Over Scan "On" or "Off". The factory default setting for this product is "Off".</p> <ul style="list-style-type: none"> • On mode will cause the image edge to appear cropped if the image size is larger than what can be displayed. • Off mode keeps the image size within the display area and displays the whole image on the screen.

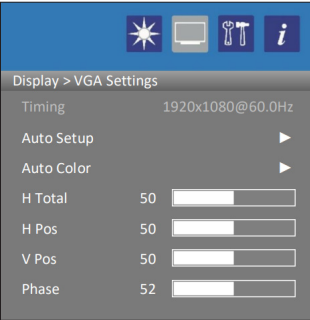
Display Menu	Description
<p>VGA Settings</p>	<p>The VGA Settings submenu includes the Timing, Auto Setup, Auto Color, H Total, H Pos, V Pos, and Phase functions.</p>  <ul style="list-style-type: none"> • Timing displays the timing mode (video signal input) coming from the graphics card in the computer. • Auto Setup automatically sizes, centers, and fine tunes the video signal to eliminate waviness and distortion. This feature may also be accessed by pressing the Select [SEL] button outside of the OSD menu. • Auto Color automatically adjusts color of the screen. • H Total allows the user to fine tune the horizontal timing by increasing or decreasing the total horizontal pixels. H total affects how the image is stretched horizontally. • H Pos moves the screen image left and right. • V Pos moves the screen image up and down. • Phase adjusts the focus of the screen image. Allows the user to remove any horizontal noise and sharpen the image of characters.

Setup Menu

The Setup menu includes the Input, Auto Scan, Advanced Setup, Reset to Factory Defaults, and OSD functions.

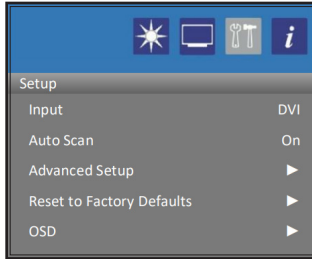

Setup Menu	Description
<p>Input</p>	<ul style="list-style-type: none"> • Allows the user to select between DisplayPort, DVI, and VGA input. • This feature may also be accessed by pressing the right [▶] button outside of the OSD menu.
<p>Auto Scan</p>	<p>Allows the user to turn Auto Scan "On" or "Off". When Auto Scan is enabled and there is no active video signal present, the display will cycle through video connections until a video source is detected. The factory default setting for this product is "On".</p>

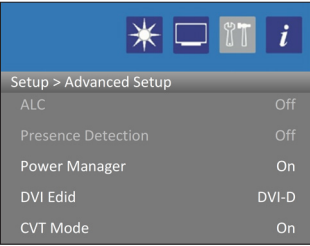
Setup Menu	Description
Advanced Setup	<p>The Advanced Setup submenu includes the ALC, Presence Detection, Power Manager, and CVT Mode functions.</p>  <ul style="list-style-type: none"> • Power Manager set to "On" (the factory default setting) will turn the display off when no video signal is detected and automatically turn the display back on when a video signal is available again. When set to "Off" the display will always stay on, even without a video signal. • DVI Edid allows the user to switch between DVI-A (analog) and DVI-D (digital) input. The factory default setting for this product is DVI-D. • CVT Mode set to "On" (the default setting) will force the display to only render VESA CVT (Coordinated Video Timings) standard signals. When set to "Off" the display will use its entire internal lookup table when syncing to an incoming video signal. CVT Mode should only be set to "Off" as a troubleshooting step if the display is having trouble syncing to an analog video signal.
Reset to Factory Defaults	<p>Returns adjustments made back to factory default settings.</p>

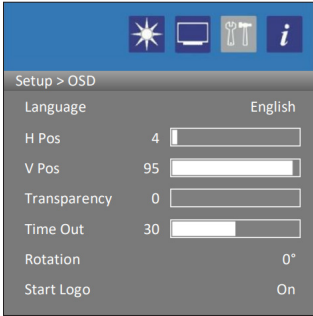
Setup Menu	Description
<p>OSD</p>	<p>The OSD submenu provides several adjustments for the OSD menu settings.</p>  <ul style="list-style-type: none"> • Language allows the user to choose the language used in the menus and control screens. Choose from English (the factory default setting), Deutsch, Español, Français, and Italiano. • H Pos moves the position of the OSD left and right. • V Pos moves the position of the OSD up and down. • Transparency adjusts the level of transparency of the OSD menu against the background. • Time out sets the length of time (in seconds) the OSD screen is displayed after the last key press. For example, with a "30" setting, if a control is not pushed within 30 seconds, the display screen disappears. The factory default setting for this product is 30 seconds. • Rotation allows the user to rotate the OSD by 0°, 90°, 180°, or 270°. The factory default setting for this product is 0°. • Start Logo allows the user to disable the power-on splash screen.

Info Menu

The Info menu includes the monitor's Software Version, Software Revision, PA, Timing, and Mode ID.

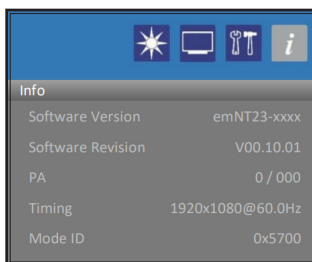

Info Menu	Description
Software Version	Software variant
Software Revision	Software version
PA	Software part number and revision
Timing	Current screen resolution and refresh rate
Mode ID	ID of the selected timing in the mode table

Cleaning Instructions



CAUTION!

DO NOT USE ABRASIVE MATERIALS, SUCH AS PAPER TOWELS OR DIRTY SHOP RAGS, ON THE DISPLAY AS IT WILL SCRATCH THE PROTECTIVE COATING. ALWAYS USE A SOFT CLOTH, PREFERABLY MADE OF COTTON.

All displays may be cleaned using any standard glass cleaner as long as there is no abrasive or oily content. Vinegar or ammonia will not hurt the screen.

The anti-reflective coatings on glass window-equipped displays are physically part of the surface of the glass and resist degradation.

Troubleshooting

Video Troubleshooting



IMPORTANT!

If using a KVM extender, first try to resolve any problems using the solutions listed below. If the problem still exists, try bypassing the KVM extender. If this fixes the problem and allows the monitor to work properly, then the KVM extender is the source of the problem. Please refer to the troubleshooting section of the KVM extender manual or contact Hope Industrial Systems for additional assistance.

Symptom	Causes	Solutions
Incorrectly displayed or partial image on the screen	Analog/VGA signal in use and monitor has not been adjusted correctly for the source signal.	<ul style="list-style-type: none"> Activate the "Auto Setup" function in the OSD's "Display > VGA Settings" menu. This function may also be activated by pressing the Select [SEL] button outside of the OSD menu. Fine tune the picture by manually adjusting the image using the settings in the OSD's "VGA Settings" menu.
	Analog/VGA signal is not a standard CVT signal (this does not apply to digital signals).	Disable the "CVT Mode" function in the OSD's "Setup > Advanced Setup" menu. This allows the monitor to use the controller board's internal mode table to display signal.
No image on the screen and control's Power Indicator light is not lit	Power cable is not plugged in.	<ul style="list-style-type: none"> Check power connections at the monitor and power source. For DC models, check the connector polarity and ensure input voltage is 9.6 to 36.6 VDC.
No image on the screen and control's Power Indicator light is lit solid red	Monitor is not powered on.	Press the Power button on the monitor to turn the monitor on and make sure the Power Indicator light is lit green.

Symptom	Causes	Solutions
No image on the screen and control's Power Indicator light is blinking orange or blinking green	Video cable is not plugged in correctly.	Check the video cable connection at the monitor, PC, and/or KVM extender.
	PC is in Power Saving mode.	Power Saving mode can usually be exited by moving the mouse or pressing a key on the keyboard.
	PC is not sending signal.	Connect PC to another known working monitor to check the PC source signal.
	Analog/VGA signal is not a standard CVT signal (this does not apply to digital signals).	Disable the "CVT Mode" function in the OSD's "Setup > Advanced Setup" menu. This allows the monitor to use the controller board's internal mode table to display signal.
"Scanning Ports / No Signal" message box and no image on the screen	Video cable is not plugged in correctly.	Check the video cable connection at the monitor, PC, and/or KVM extender.
	PC is not powered on.	Ensure PC is powered on.
	PC is not sending signal.	Connect PC to another known working monitor to check the PC source signal.
"VGA / Out of Range" or "DVI / Out of Range" message box and no image on the screen	The source signal exceeds the maximum resolution and/or refresh rate that the monitor can handle (> 1680 x 1050 resolution or > 75 Hz refresh rate).	Adjust the computer settings to the monitor's native resolution: 1680 x 1050 @ 60 Hz
Wrong or abnormal colors (white is not white)	Monitor color settings are incorrectly adjusted.	Reset monitor to the default settings by activating "Reset to factory defaults" function in the OSD's "Setup" menu.
	Analog/VGA signal in use and monitor color settings are incorrectly adjusted.	Adjust monitor settings by running the "Auto Color" function in the OSD's "Display > VGA Settings" menu.
	Video cable is not securely connected.	If any colors (red, green, or blue) are missing, check the video cable to make sure it is securely connected.
	Video cable is bad.	Ensure no loose or broken pins in the cable connector. Shorts in cable could also cause improper image to display.
Screen image is dim	Backlight and/or contrast settings not set properly.	Adjust the monitor's backlight and/or contrast settings in the OSD's "Picture" menu.

Touch Screen Troubleshooting

Applies to touch screen monitors only. To be sure that you have the most current driver, please check the following address:

<https://www.HopeIndustrial.com/support/drivers/>

Symptom	Causes	Solutions
No response when touching the touch screen	Touch screen cable is not plugged in correctly.	Make sure either the USB or Serial touch screen cable is securely connected to the monitor and PC. Do not connect both.
	USB cable length exceeds 5 meters.	USB cables have a 5 meter limitation. Exceeding this length may cause connection issues without the use of a USB or KVM extender device. Please contact Hope Industrial support for extension options.
	Serial connection in use, but touch screen driver has not been installed.	With a Serial connection, no touch will be detected until the touch screen driver is installed. See section "Installing the Driver: Serial (RS-232) Connections" above.
	Serial connection in use, but connection to computer is not using the same port for which the touch screen driver is installed.	The Serial cable must be connected to the computer's COM port prior to driver installation to allow touch screen detection and association with the correct COM port. To fix, uninstall the driver, reboot the computer, then follow instructions in section "Installing the Driver: Serial (RS-232) Connections" above. Be sure to connect the touch screen serial port before installing the driver.
The screen responds to touch, but does not follow my finger	Touch screen driver has not been installed and the touch screen has not been calibrated.	Follow instructions for driver installation and calibration in section "Connect and Set Up Touch Screen" above.
	Touch screen driver has been installed, but the touch screen has not been calibrated.	Follow instructions for calibration in section "Calibrate the Touch Screen" above.

Specifications

Display	
Type	Thin-film transistor (TFT) Active Matrix Liquid Crystal
Size	22" diagonal
Image Size (W x H)	473.8 mm x 296.1 mm (18.65" x 11.66")
Native Resolution	WSXGA+ (1680 x 1050, 16:10 aspect ratio)
Minimum Resolution	VGA (640 x 480)
Pixel Pitch	0.282 mm x 0.282 mm
Number of Colors	16.7 million
Brightness (white)	250 nits (cd/m ²)
Viewing Angle (Hori/Vert)	170° / 160°
Contrast Ratio (typical)	1000:1
Backlight (typical)	LED; 50,000 hour brightness half-life

Environmental	
Operating Temperature	0° to 50°C (32° to 122°F)
Storage Temperature	-20° to 60°C (-4° to 140°F)
Humidity	20% to 90% non-condensing
Operating Shock	15 g, 6 msec, half-sine
Operating Vibration (sine)	1.0g, swept sine 9 – 500 Hz
Transport Vibration (random)	0.1g ² / Hz, 10 – 200 Hz 0.03g ² / Hz, 200 – 2000 Hz
Altitude	<ul style="list-style-type: none"> Operating: up to 10,000 feet Non-operating: up to 40,000 feet

Video	
Input Connectors	<ul style="list-style-type: none"> • DVI-I, DisplayPort • Optional adapters are available for other connection types (contact Hope Industrial Systems for details)
Input Signal Formats	<ul style="list-style-type: none"> • RGB Analog video, 0.7/1.0 Vp-p, 75 Ohms <p>Compatible sync modes: Separate H/V sync, Composite sync, Sync on Green</p> <ul style="list-style-type: none"> • DVI (HDMI via adapter) • DisplayPort 1.2 <p>NOTE: NTSC/PAL composite input available (call for details)</p>
Horizontal Scan	31 – 80 kHz
Vertical Scan	48 – 78 Hz
Common Supported Video Signal Formats (not a complete list)	<ul style="list-style-type: none"> • 1680 x 1050p @ 60 Hz • 1280 x 1024p @ 75 Hz • 1152 x 870p @ 75 Hz • 1024 x 768p @ 60, 70, 75 Hz • 720 x 400p @ 70 Hz • 640 x 480p @ 60, 67, 72, 75 Hz • 800 x 600p @ 56, 60, 72, 75 Hz • 832 x 624p @ 75 Hz
Response Time (typical)	5 ms

Functional	
Control Panel Buttons	Menu, SEL (Navigate Down / Auto Setup), ◀ (Left / Down / Backlight Adjustment), ▶ (Right / Up / Input Source), Power
On-Screen Display (OSD) Menus	Backlight, Contrast, Saturation, Sharpness, Color Balance, User Color, Gamma, Aspect Ratio, Over Scan, VGA Settings, Input, Auto Scan, Advanced Setup, Reset to Factory Defaults, OSD, Info
Touch Screen Option	5-wire single-touch resistive sensor; Serial (RS-232) and USB interface to host computer

Physical	
Enclosure Type	Panel mount; rear collar compresses gasket against panel (5/16" maximum panel thickness); held by 14 M5 studs
Panel Rating (with proper installation)	Built to IP65/IP66 standards <ul style="list-style-type: none"> • NEMA/UL Type 12/4 (Black Powder-Coated Faceplate) • NEMA/UL Type 12/4/4X (Stainless Steel Faceplate)
Depth	<ul style="list-style-type: none"> • Total Product Depth – 57.2 mm (2.25") • Depth Behind Front Edge of Panel – 50.1 mm (1.97") <p>NOTE: Design to maximum depth of 63.5 mm (behind front edge of panel) to ensure future compatibility with later revisions and replacement units.</p>
Front Bezel Outside Dimensions (W x H x D)	558.8 mm x 374.7 mm x 7.1 mm (22.00" x 14.75" x 0.28") (not including gasket)
Cutout Dimensions (W x H)	528.7 mm x 342.3 mm (20.81" x 13.48"); ± 0.5 mm (0.020")
Net Weight	8.62 kg (19 lbs.)
Shipping Weight	10.43 kg (23 lbs.)

Electrical	
Monitor Input	<ul style="list-style-type: none"> • AC power models – 100 to 240 VAC, 1.5/0.75 A, 60/50 Hz • DC power models – 9.6 to 36.6 VDC, 2.5 to 0.65 A, Class 2 or SELV/LPS
Power Consumption	~ 13 W
Power Consumption (Standby mode)	< 1.5 W

Compliances and Certifications	
Electrical	<ul style="list-style-type: none"> UL/EN/IEC62368-1, UL Recognized Component (File No. E212889) UL 508A Listed (File No. E318630) FCC Class A CAN ICES-3A/NMB-3A CE UKCA NOM (Registration No. NOM-019-SCFI-1998) <p>NOTE: DC power must use shielded DC input cable</p>
Environmental	<ul style="list-style-type: none"> IEC 60721-3 (Reliability) WEEE <ul style="list-style-type: none"> Unique Identifier Number (France): FR041915_050NLX WEEE Registration Number (Germany): DE 78623714 WEEE Registration Number (Ireland): IE03575W WEEE Registration Number (Italy): IT21120000013548 WEEE Registration Number (Spain): 7947 WEEE Registration Number (UK): WEE/DJ1859ZX
Enclosure	UL 50E (File No. E318630)
Hazardous Location	<ul style="list-style-type: none"> AC power models: UL Rated for Hazardous Locations: Industrial Control Equipment for Hazardous Location: Listed for Class I, Division 2 for Groups A, B, C, and D; Class II, Division 2 for Groups F and G; Class III; Temp Code T5 (File No. E328481) per UL121201-2017 and CAN/CSA C22.2 No. 213-17 DC power models: UL Rated for Hazardous Locations: Industrial Control Equipment for Hazardous Location: Listed for Class I, Division 2 for Groups A, B, C, and D; Class II, Division 2 for Groups F and G; Class III; Temp Code T4A (File No. E328481) per UL121201-2017 and CAN/CSA C22.2 No. 213-17

Warranty Statement

Who is Covered?

This warranty covers the purchaser of this product only and is not transferable without our written consent.

What Does This Warranty Cover and What is the Period of Coverage?

We warrant this product to be free from defects in material and workmanship, subject to the conditions set forth below. The warranty remains in force for a five year period beginning on the date we invoice you. If Hope Industrial Systems repairs or replaces a product under warranty, its warranty term is not extended, but the repair itself is warranted for 90 days.

What Will We Do to Correct Problems?

We will repair or replace (at our sole option) any part of the unit which proves to be defective. Replacement parts may be new or refurbished and will meet the same specifications of the original parts or unit. For orders sold through our U.S. operations, at our expense we will return the product to any location within the U.S.A. via the shipping method of our choice. Shipping fees for products returned to customers outside the U.S.A. are the responsibility of the customer. For products originally sold through Hope Industrial E.U. or U.K., return shipping to and from Hope Industrial repair facilities and any EU member country (except Croatia, Cyprus, and Malta) will be provided using a pre-paid UPS shipping label sent via email.

How Do You Get Service?

In order to receive warranty service you must get prior approval from Hope Industrial Systems. To request warranty service you can contact our customer service representatives. If we determine that warranty service is needed we will give you a Return Material Authorization (RMA) number. This RMA number must be conspicuously marked on the outside of the shipping box. Hope Industrial Systems will not accept shipments not accompanied by the RMA number. Except where otherwise noted, you must ship or deliver the product to Hope Industrial Systems Freight prepaid.

What Does This Warranty Not Cover?

This warranty does not cover equipment which has been damaged due to misuse, abuse or accident such as: operating the equipment outside of published specifications; exposure to chemicals or gases not covered by specified IP/NEMA standards; displaying fixed images for long periods of time resulting in afterimage effects; improper or unauthorized repair by anyone other than Hope Industrial Systems or a service agency authorized by Hope Industrial Systems to perform such repairs; fire, flood, "acts of God", or other contingencies beyond the control of Hope Industrial Systems.

Hope Industrial Systems' responsibility for malfunctions and defects in hardware is limited to repair and replacement as set forth in this warranty statement. Hope Industrial Systems shall not be liable for direct, indirect, incidental, consequential, or other types of damages resulting from the use of any Hope Industrial Systems product other than the liability stated above. These warranties are in lieu of all other warranties express or implied, including, but not limited to, the implied warranties of merchantability or fitness for a particular purpose. Some states do not allow the exclusion of implied warranties or the limitation or exclusion of liability for incidental or consequential damages so the above exclusions or limitations may not apply to you. You are cautioned that the performance of this product can be affected by many factors, such as system configuration, software, application, and operator control of the system. It is your responsibility to determine suitability of this product for your purpose and application.

(This page intentionally left blank.)



Hope Industrial Systems, Inc.

US / International

1325 Northmeadow Parkway
Roswell, GA 30076
United States

Toll Free: (877) 762-9790 | **International:** +1 (678) 762-9790 | **Fax:** +1 (678) 762-9789

Sales and Customer Service: sales@HopeIndustrial.com

Support and Returns: support@HopeIndustrial.com

Accounting Department: accounting@HopeIndustrial.com

www.HopeIndustrial.com

EU Authorized Representative:

Falcons Logistics B.V.
Barnsteen 4
2132 MV Hoofddorp
Netherlands

HopeIndustrial.eu

Phone: +31 20 241 0853

Sales: sales@HopeIndustrial.eu

Support: support@HopeIndustrial.eu

Accounting: accounting@HopeIndustrial.eu

United Kingdom Authorized Representative:

Falcon AR Services UK LTD
Lynton House
7-12 Tavistock Square
WC1H 9LT London
United Kingdom

HopeIndustrial.co.uk

Phone: +44 (0) 20 7193 2618

Sales: sales@HopeIndustrial.co.uk

Support: support@HopeIndustrial.co.uk

Accounting: accounting@HopeIndustrial.co.uk

France

Phone: +33 8 05 08 05 19

HopeIndustrial.fr

Germany

Phone: +49 800 001 0486

HopeIndustrial.de

Italy

Phone: +39 80 0740414

HopeIndustrial.it

Spain

Phone: +34 91 1438229

HopeIndustrial.es

Mexico

Phone: +52 800 9531935

HopeIndustrial.mx

